



ENTOUR FAZE



Caution: Fog Machines may set off Smoke Alarms!

User Instructions

©2018 ADJ Products, LLC all rights reserved. Information, specifications, diagrams, images, and instructions herein are subject to change without notice. ADJ Products, LLC logo and identifying product names and numbers herein are trademarks of ADJ Products, LLC. Copyright protection claimed includes all forms and matters of copyrightable materials and information now allowed by statutory or judicial law or hereinafter granted. Product names used in this document may be trademarks or registered trademarks of their respective companies and are hereby acknowledged. All non-ADJ Products, LLC brands and product names are trademarks or registered trademarks of their respective companies.

ADJ Products, LLC and all affiliated companies hereby disclaim any and all liabilities for property, equipment, building, and electrical damages, injuries to any persons, and direct or indirect economic loss associated with the use or reliance of any information contained within this document, and/or as a result of the improper, unsafe, insufficient and negligent assembly, installation, rigging, and operation of this product.

DOCUMENT VERSION

Please check www.adj.com for the latest revision/update of this guide.

Date	Document Version	Software Version \geq	DMX Channel Mode	Notes
08/13/18	1.2	U27	1 / 2 / 4	Updated Release

Europe Energy Saving Notice

Energy Saving Matters (EuP 2009/125/EC)

Saving electric energy is a key to help protecting the environment. Please turn off all electrical products when they are not in use. To avoid power consumption in idle mode, disconnect all electrical equipment from power when not in use. Thank you!

Introduction: Congratulations, you have just purchased one of the most reliable faze machines on the market today! The Entour Faze machine has been designed to perform reliably for years when the guidelines in this booklet are followed. Please read and understand the instructions in this manual carefully and thoroughly before attempting to operate this unit. These instructions contain important information regarding safety during use and maintenance.

Customer Support: ADJ Products, LLC provides a toll free customer support line, to provide set up help and to answer any question should you encounter problems during your set up or initial operation. You may also visit us on the web at www.adj.com for any comments or suggestions. For service related issue please contact ADJ Products, LLC. Service Hours are Monday through Friday 8:00 a.m. to 4:30 p.m. Pacific Standard Time.

Voice: (323) 582-2650

Fax: (323) 582-2941

E-mail: support@americandj.com

To purchase parts online visit <http://parts.americandj.com>

Warning! To prevent or reduce the risk of electrical shock or fire, do not expose this unit to rain or moisture.

Caution! There are no user serviceable parts inside this unit. Do not attempt any repairs yourself, doing so will void your manufactures warranty. In the unlikely event your unit may require service please contact ADJ Products, LLC.

Do not discard the shipping cartoon in the trash. Please recycle when ever possible.

SAFETY ISSUES:

NEVER POINT OR AIM A FOG MACHINE TOWARDS PEOPLE OR THEIR CLOTHING. THIS UNIT EMITS HOT VAPOR AND SHOULD BE USED WITH THE SAME CARE THAT YOU WOULD OBSERVE WHEN USING AN ELECTRIC KETTLE OR IRON.

Please Note: *Specifications and improvements in the design of this unit and this manual are subject to change without any prior written notice.*

- Be sure to save the packing carton in the unlikely event the unit may have to be returned for service
- Do not spill water or other liquids into or on to your fazer. Be sure that all the fog fluid is kept inside the fluid reservoir
- Be sure that the local power outlet match that or the required voltage for your fog machine
- Do not remove the top cover under any conditions. There are no user serviceable parts inside
- Disconnect the unit's main power when left unused for long periods of time
- Never connect this unit to a dimmer pack
- Do not attempt to operate this unit, if it becomes damaged in anyway
- Never operate this unit when it's cover is removed
- To reduce the risk of electrical shock or fire, do not expose this unit rain or moisture
- Do not attempt to operate this unit if the power cord has been frayed or broken. Do not attempt to remove or break off the ground prong from the electrical cord. This prong is used to reduce the risk of electrical shock and fire in case of an internal short
- Disconnect from main power before making any type of connection
- Never block the ventilation holes. Always be sure to mount this unit in an area that will allow proper ventilation. Allow about 6" (15cm) between this device and a wall
- This unit is intended for indoor use only, use of this product outdoors voids all warranties
- Always mount this unit in a safe and stable matter
- Please route your power cord out of the way of foot traffic. Power cords should be routed so they are not likely to be walked on, pinched by items placed upon or against them
- The unit should only be serviced by qualified service personnel when:
 - A. The power-supply cord or the plug has been damaged.
 - B. Objects have fallen, or liquid has been spilled into the unit.
 - C. The unit has been exposed to rain or water.
 - D. The appliance does not appear to operate normally or exhibits a marked change in performance.

Power Supply: Before plugging your unit in, be sure the source voltage in your area matches the required voltage for your ADJ Entour Faze. The ADJ Entour Faze is available in a 120v and 240v version. Because line voltage may vary from venue to venue, you should be sure your unit voltage matches the wall outlet voltage before attempting to operate you fixture.

DMX-512: DMX is short for Digital Multiplex. This is a universal protocol used as a form of communication between intelligent fixtures and controllers. A DMX controller sends DMX data instructions from the controller to the fixture. DMX data is sent as serial data that travels from fixture to fixture via the DATA “IN” and DATA “OUT” XLR terminals located on all DMX fixtures (most controllers only have a DATA “OUT” terminal).

DMX Linking: DMX is a language allowing all makes and models of different manufactures to be linked together and operate from a single controller, as long as all fixtures and the controller are DMX compliant. To ensure proper DMX data transmission, when using several DMX fixtures try to use the shortest cable path possible. The order in which fixtures are connected in a DMX line does not influence the DMX addressing. For example; a fixture assigned a DMX address of 1 may be placed anywhere in a DMX line, at the beginning, at the end, or anywhere in the middle. When a fixture is assigned a DMX address of 1, the DMX controller knows to send DATA assigned to address 1 to that unit, no matter where it is located in the DMX chain.

Data Cable (DMX Cable) Requirements (For DMX Operation):

The Entour Faze can be controlled via DMX-512 protocol. The Entour Faze has 3 DMX channel modes, 1 channel, 2 channel, and 4 channel. The DMX address is set on the back panel. Your unit and your DMX controller require a standard 3-pin XLR connector for data input and data output (Figure 1). We recommend Accu-Cable DMX cables. If you are making your own cables, be sure to use standard 110-120 Ohm shielded cable (This cable may be purchased at almost all pro lighting stores). Your cables should be made with a male and female XLR connector on either end of the cable. Also remember that DMX cable must be daisy chained and cannot be split.



Figure 1

Notice: Be sure to follow figures two and three when making your own cables. Do not use the ground lug on the XLR connector. Do not connect the cable’s shield conductor to the ground lug or allow the shield conductor to come in contact with the XLR’s outer casing. Grounding the shield could cause a short circuit and erratic behavior.

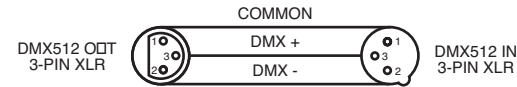

Figure 2

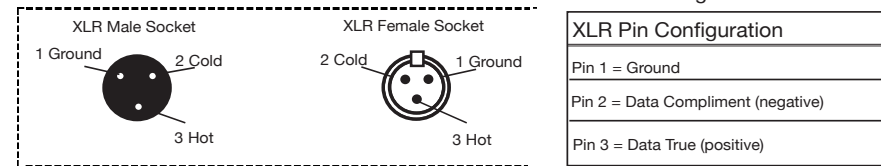

Figure 3

Special Note: Line Termination. When longer runs of cable are used, you may need to use a terminator on the last unit to avoid erratic behavior. A terminator is a 110-120 ohm 1/4 watt resistor which is connected between pins 2 and 3 of a male XLR connector (DATA + and DATA -). This unit is inserted in the female XLR connector of the last unit in your daisy chain to terminate the line. Using a cable terminator (ADJ part number Z-DMX/T) will decrease the possibilities of erratic behavior.



Termination reduces signal errors and avoids signal transmission problems and interference. It is always advisable to connect a DMX terminal. (Resistance 120 Ohm 1/4 W) between PIN 2 (DMX-) and PIN 3 (DMX +) of the last fixture.

Figure 4

5-Pin XLR DMX Connectors. Some manufactures use 5-pin DMX-512 data cables for DATA transmission in place of 3-pin. 5-pin DMX fixtures may be implemented in a 3-pin DMX line. When inserting standard 5-pin data cables in to a 3-pin line a cable adaptor must be used, these adaptors are readily available at most electric stores. The chart below details a proper cable conversion.

3-Pin XLR to 5-Pin XLR Conversion		
Conductor	3-Pin XLR Female (Out)	5-Pin XLR Male (In)
Ground/Shield	Pin 1	Pin 1
Data Compliment (- signal)	Pin 2	Pin 2
Data True (+ signal)	Pin 3	Pin 3
Not Used		Do Not Use
Not Used		Do Not Use

Entour Faze

Overview

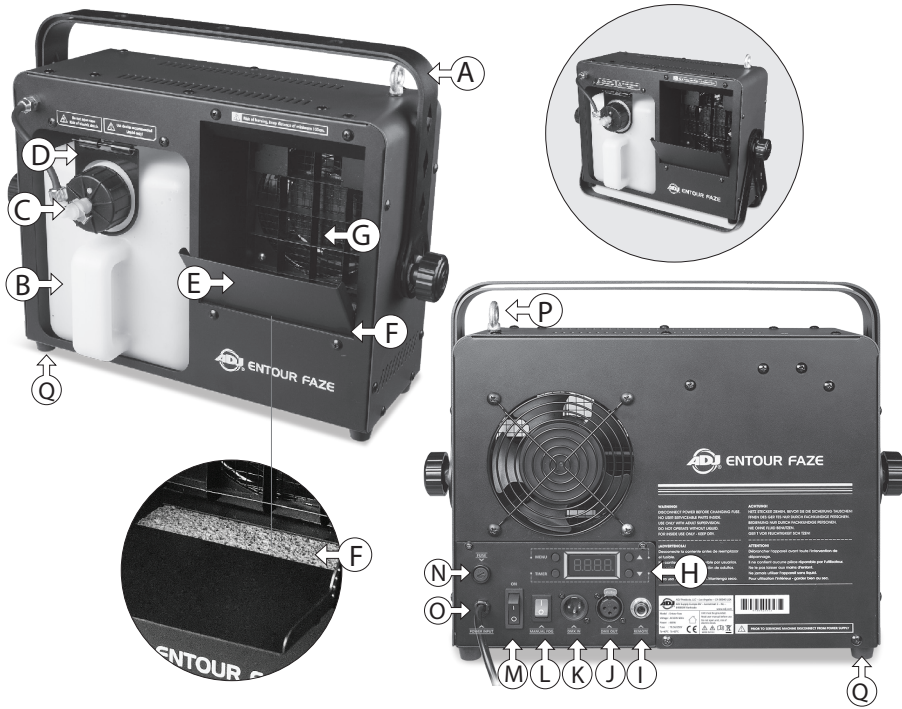

Entour Faze

Mounting/Hanging

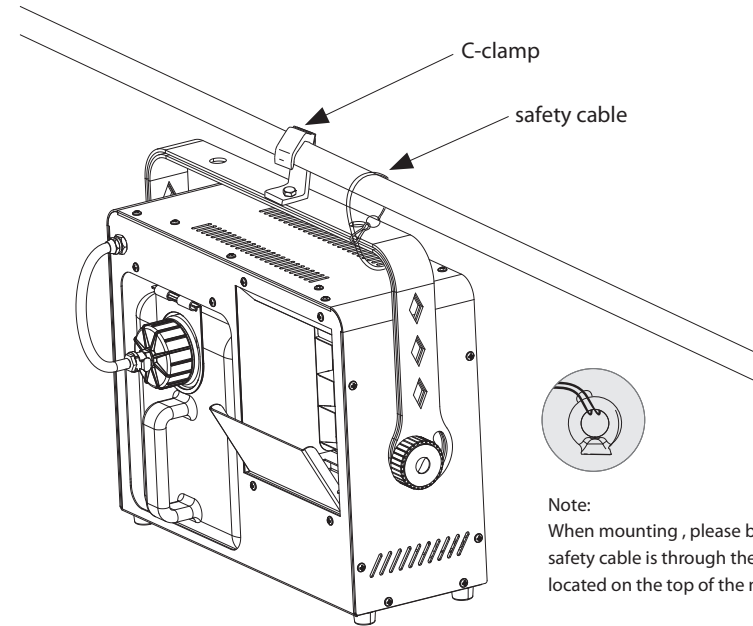

Entour Faze

Dimensional Drawing

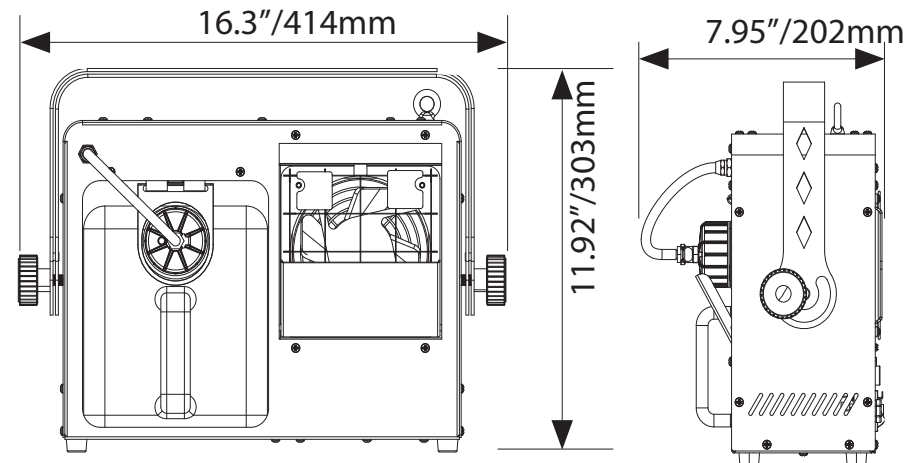

- A. Hanging Bracket with handle screw (used as a tripod)
- B. Tank
- C. Quick Connector
- D. Fixed Ring
- E. Air Deflector
- F. Sponge
- G. Smoke Output
- H. LED Display/4 Function Buttons
- I. Control Socket Connection
- J. DMX 3 pin XLR Output
- K. DMX 3 pin XLR Input
- L. Manual Fog
- M. Power ON/OFF
- N. Fuse
- O. Electric Power Input
- P. Safety Ring
- Q. Resting Feet

Entour Faze

General Set Up

1. Open the shipping carton and carefully remove the unit from the shipping carton.
2. Be sure to remove all the packing material especially around the output area.
3. Set the faze machine on a flat dry surface and fill the fog fluid reservoir with American DJ brand ECO juice. Place the feeder tube with the filter deep inside the reservoir and tighten the cap. **NOTE: It is highly recommended to use American DJ ECO fog juice.**
4. Plug the unit in to a matching power supply and the unit will begin to heat up. Wait about 45 seconds for the machine to reach normal operating temperature.
5. Follow the operating instructions on the next pages for proper operation.

Entour Faze

Control Panel

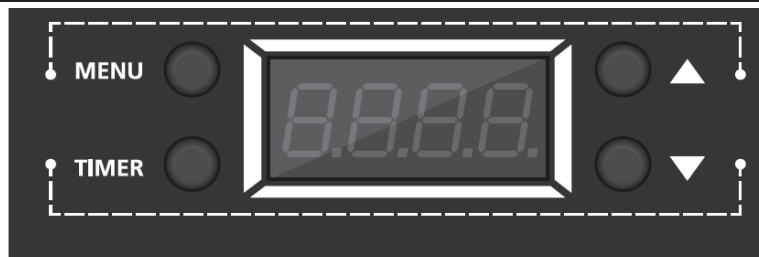

MENU BUTTON - Press this button to cycle between DMX addressing, fan adjustment, duration adjustment, and interval adjustment. Use the UP and DOWN buttons to make your desired adjustments.

TIMER ON/OFF BUTTON - Press this button to activate/deactivate the timer function.

UP BUTTON - Use this button to make adjustments to DMX addressing, DMX channel mode, duration setting, and interval setting.

DOWN BUTTON - Use this button to make adjustments to DMX addressing, DMX channel mode, duration setting, and interval setting.

Entour Faze

System Menu

DMX Address: Setting of DMX address. Range of address value: address=001~512.
 Press UP or Down 1.5 seconds can change value continuously and fast, pressed UP/DOWN at the same time, value back to 1.

DMX Mode: DMX mode selection. Single channel, 2 channels and 4 channels mode can be selected.

Volume : Setting output of timing fogging and continuous fogging (Volume=5~100%).

Interval : Setting interval of timing fogging (Interval=20-900s).

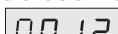
Duration : Setting duration of timing fogging (Duration=10-200s).

Heat Preservation: Setting duration of heating preservation (Duration = 1 min. -200 mins. - no limit). 
Under status of standby, duration of kept temperature of the heater, heater keeps heating up steadily by lower temperature to start fogging more quickly.

NOTE: If running manual mode and you would like to keep your timer settings, press timer, then press it again. The display should read "PICL". The machine is now emptying all the fluids from the pump and piping. This will take a minute and a half. After this process is finished, you can then shutdown the machine. When you turn the machine on again and press timer, your last settings before shutting down should still be there. Do not shutdown the machine without running the cleaning process.

Entour Faze

Fluid Inspection On/Off

When this function is activated the machine will detect if any fluid is in the reservoir. If there is no fluid the machine will not go into work mode. When activated the machine will stop working when the fluid runs out.

1. Press the MODE button until “FXXX” is displayed. “XXX” represents the current setting.
2. To activate the fluid inspection function, press the UP or DOWN buttons so that “F001” is displayed.
3. To deactivate the fluid inspection function, press the UP or Down buttons so that “F000” is displayed.
4. If there is no fluid in the tank, “no F” will be displayed.

Entour Faze

Start Up

START UP:

1. Plug the power cord into a matching power source and put the power switch into the “On” position. The current software version will be displayed.
2.  2 Seconds after power is applied the unit will begin to warm up.
3. After the machine has fully heated up, the last function before power was shut off will be displayed. Follow the directions on the next few pages for the different operating modes.

Entour Faze

Operation

MANUAL FOGGING:

1. Put the MANUAL button in the “On” position. The output can be adjusted using the UP or DOWN buttons. To stop manual fogging put the MANUAL button into the “Off” position.
2. When you stop manual fogging the display will read “PICL”. This process is cleaning the excess fluid out of the pump and tubing. After this process is done the display will show “Stby”.

NOTE: Please let this process run its course before shutting off the faze machine.

Entour Faze	DMX Mode
-------------	----------

DMX Mode:

The Entour Faze has 3 DMX channel modes; 1 channel mode, 2 channel mode, and 4 channel mode. See page 13 for the DMX traits.

1. This function will allow you to control each individual fixtures traits with a standard DMX 512 controller.
2. Press the MENU button until “AXXX” is displayed. “XXX” represents the current DMX channel address. Press the UP or DOWN buttons to find your desired DMX address.
3. To select your desired channel mode press the MENU button until “CXXX” is displayed. “XXX” represents the current DMX channel mode. Press the UP or DOWN buttons to find your desired DMX channel mode.
4. Connect your DMX controller to the unit.
5. When 4 channel mode is selected, after about 5 seconds the screen will change to the display shown below.

NOTE: Duration and Interval setting is only available in 4 Channel mode.

When you have finished fogging the display will read “PICL”. This process is cleaning the excess fluid out of the pump and tubing. After this process is done the display will show “Stby”.

NOTE: Please let this process run its course before shutting off the faze machine.

Entour Faze		1 Channel Mode
Channel	Value	Function
1	0 - 255	OUTPUT VOLUME 0% - 100% OUTPUT VOLUME

Entour Faze		2 Channel Mode
Channel	Value	Function
1	0 - 255	OUTPUT VOLUME 0% - 100% OUTPUT VOLUME
2	0 - 127 128 - 255	FAN OFF ON

Entour Faze		4 Channel Mode
Channel	Value	Function
1	0 - 255	OUTPUT VOLUME 0% - 100% OUTPUT VOLUME
2	0 - 127 128 - 255	FAN OFF ON
3	0 - 9 10 - 255	DURATION 0 SECONDS 10 - 255 SECONDS
4	0 - 1 9 - 255	INTERVAL 0 SECONDS 5 - 255 SECONDS



A- 1/4" stereo jack

B- Knob

C- Green LED (Volume output)

D- Red LED (power)

The fluid cannot get dirty. Always make sure the cap is clean and the fog fluid line. Periodically nozzle maybe come clogged by impurities contact ADJ customer service for a replacement nozzle.

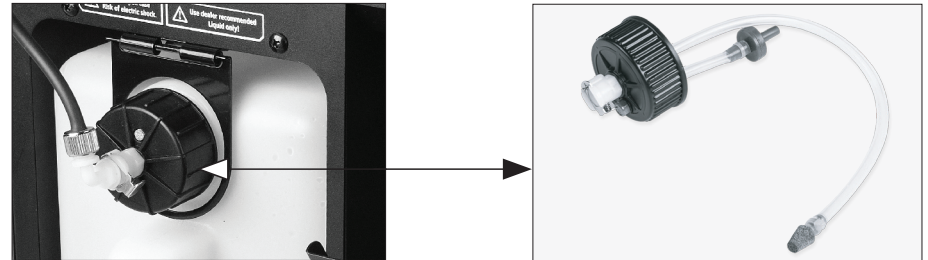

With prolonged use, the the sponge inside the vent may accumulate oil. Periodically clean the sponge or replace with a new one. If you would like to replace the sponge, contact ADJ customer service.

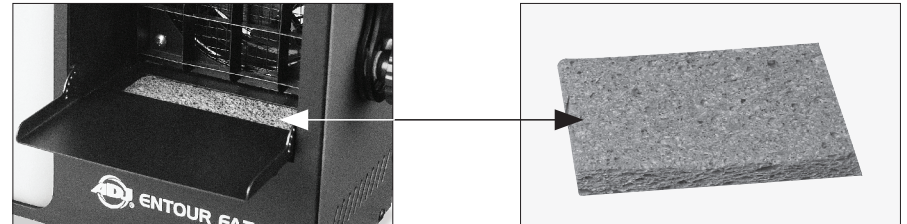

When storing your fog machine be sure to store it in a cool area. Cover the machine so that dust does not build up on the unit. When storing the machine for long periods of time, it is highly advised to at least run the machine every 3-4 months. Long periods of inactivity can severely shorten the life of your machine. Only run water based fog juice through your machine. Never run plain water, vinegar, or any other liquid solution through your machine. Running anything other then water based fog juice will severely damage your machine.

Entour Faze

Warranty Registration

The Entour Faze fog machine carries a one year (365 days) limited warranty. Please fill out the enclosed warranty card to validate your purchase. All returned service items whether under warranty or not, must be freight pre-paid and accompany a return authorization (R.A.) number. The R.A. number must be clearly written on the outside of the return package. A brief description of the problem as well as the R.A. number must also be written down on a piece of paper and included in the shipping container. If the unit is under warranty, you must provide a copy of your proof of purchase invoice. You may obtain a R.A. number by contacting customer support at (800) 322-6337.

Entour Faze

Trouble Shooting

Power Connected but No Smoke is Emitted:

1. Check the power supply. Plug the unit into a grounded electric power supply socket with proper voltage.
2. Disconnect the machine from the power supply and replace the fuse with a matching fuse.
3. Be sure there is sufficient fluid in the tank.
4. Make sure the pump is working properly (with fluid flow on/off).
5. If using DMX, make sure the controller is connected correctly.
6. Check your DMX addressing.

If you experience low fog output, pump noise, or no fog output at all, disconnect and discontinue use immediately. Do not attempt to continue pushing the remote control's activation button as this may damage the fog machine. Check the fluid level, the fuse, and be sure the wall outlet is sending power. If all of the above appears to be okay, and the unit fails to operate correctly, the unit will require service. Please contact ADJ Products, LLC.

Entour Faze

Warranty

MANUFACTURER'S LIMITED WARRANTY

- A. ADJ Products, LLC hereby warrants, to the original purchaser, ADJ Products, LLC products to be free of manufacturing defects in material and workmanship for a prescribed period from the date of purchase (see specific warranty period on reverse). This warranty shall be valid only if the product is purchased within the United States of America, including possessions and territories. It is the owner's responsibility to establish the date and place of purchase by acceptable evidence, at the time service is sought.
- B. For warranty service you must obtain a Return Authorization number (RA#) before sending back the product—please contact ADJ Products, LLC Service Department at 800-322-6337. Send the product only to the ADJ Products, LLC factory. All shipping charges must be pre-paid. If the requested repairs or service (including parts replacement) are within the terms of this warranty, ADJ Products, LLC will pay return shipping charges only to a designated point within the United States. If the entire instrument is sent, it must be shipped in its original package. No accessories should be shipped with the product. If any accessories are shipped with the product, ADJ Products, LLC shall have no liability whatsoever for loss of or damage to any such accessories, nor for the safe return thereof.
- C. This warranty is void if the serial number has been altered or removed; if the product is modified in any manner which ADJ Products, LLC concludes, after inspection, affects the reliability of the product; if the product has been repaired or serviced by anyone other than the ADJ Products, LLC factory unless prior written authorization was issued to purchaser by ADJ Products, LLC; if the product is damaged because not properly maintained as set forth in the instruction manual.
- D. This is not a service contract, and this warranty does not include maintenance, cleaning or periodic check up. During the period specified above, ADJ Products, LLC will replace defective parts at its expense with new or refurbished parts, and will absorb all expenses for warranty service and repair labor by reason of defects in material or workmanship. The sole responsibility of ADJ Products, LLC under this warranty shall be limited to the repair of the product, or replacement thereof, including parts, at the sole discretion of ADJ Products, LLC. All products covered by this warranty were manufactured after August 15, 2012, and bear indentifying marks to that effect.
- E. ADJ Products, LLC reserves the right to make changes in design and/or improvements upon its products without any obligation to include these changes in any products theretofore manufactured.

No warranty, whether expressed or implied, is given or made with respect to any accessory supplied with products described above. Except to the extent prohibited by applicable law, all implied warranties made by ADJ Products, LLC in connection with this product, including warranties of merchantability or fitness, are limited in duration to the warranty period set forth above. And no warranties, whether expressed or implied, including warranties of merchantability or fitness, shall apply to this product after said period has expired. The consumer's and/or Dealer's sole remedy shall be such repair or replacement as is expressly provided above; and under no circumstances shall ADJ Products, LLC be liable for any loss or damage, direct or consequential, arising out of the use of, or inability to use, this product.

This warranty is the only written warranty applicable to ADJ Products, LLC Products and supersedes all prior warranties and written descriptions of warranty terms and conditions heretofore published.

MANUFACTURER'S LIMITED WARRANTY PERIODS:

- **Non L.E.D. Lighting Products = 1-year (365 days) Limited Warranty** (Such as: Special Effect Lighting, Intelligent Lighting, UV lighting, Strobes, Fog Machines, Bubble Machines, Mirror Balls, Par Cans, Trussing, Lighting Stands etc. excluding LED and lamps)
- **Laser Products = 1 Year (365 Days) Limited Warranty** (excluding laser diodes which have a 6 month limited warranty)
- **L.E.D. Products = 2-year (730 days) Limited Warranty** (excluding batteries which have a 180 day limited warranty). **Note: 2 Year Warranty only applies to purchases within the United States.**
- **StarTec Series = 1 Year Limited Warranty** (excluding batteries which have a 180 day limited warranty).
- **ADJ DMX Controllers = 2 Year (730 Days) Limited Warranty**

Entour Faze**Specifications****MODEL - Entour Faze**

VOLTAGE*:	120v or 230V, 50/60Hz
HEATER:	450W
POWER CONSUMPTION:	465W
WEIGHT:	10 Lbs. / 4.5 Kgs
DIMENSIONS:	15.5" (L) x 17" (W) x 10" (H) 202 x 414 x 303mm
FUSE:	7A (120V) / 4A (230V)
WARM UP TIME:	45 Seconds
TANK CAPACITY:	3 Liters
OUTPUT:	4,000 cubic feet per minute (With Fan and Volume Full On)
FLUID CONSUMPTION (ml/min):	4.5ml/min (Max Output)
FLUID TYPE:	Water Based American DJ ECO Fog Juice
DMX CHANNELS:	3 DMX Channel Modes: 1/2/4
DUTY CYCLE:	Not to exceed 6 hours turned on.
INCLUDED ACCESSORIES:	3 Meter Wired Remote Control

**Voltage is preset at the factory and may not be changed*

ADJ Products, LLC
6122 S. Eastern Ave. Los Angeles, CA 90040 USA
Tel: 323-582-2650 / Fax: 323-582-2941
www.adj.com / support@americandj.com

A.D.J. Supply Europe B.V.
Junostraat 2
6468 EW Kerkrade
The Netherlands

www.adj.eu / support@adj.eu

Tel: +31 45 546 85 00 / Fax: +31 45 546 85 99

Follow Us On:



facebook.com/americandj
twitter.com/americandj
youtube.com/adjlighting